

**de** Montageanleitung  
**en** Mounting instructions  
**fr** Instructions de montage  
**sv** Monteringsinstruktion  
**nl** Montage-aanwijzing  
**it** Istruzioni di montaggio  
**fi** Asennusohje  
**es** Instrucciones de montaje  
**da** Monteringsvejledning  
**zh** 安装指导  
**ko** 설치 지침서  
**ja** 取扱説明書

**Drehantrieb**  
**Rotary-type actuator**  
**Servo-moteur à action angulaire**  
**Spjällställdon med vridande rörelse**  
**Luchtklepservomotor voor rot. aandrijving**  
**Servocomando rotativo per serrande**  
**Kiertoliikkeinen ilmapeltien toimimoottori**  
**Actuador de acción rotativa**  
**Motor for drejebævgelse**  
**旋转型执行器**  
**로터리타입 조작기**  
**ロータリー式ダンパーアクチュエータ**

**GDB..1E**  
**GLB..1E**

**A**

**Lieferumfang**  
**Deliverables**  
**Contenu**  
**Leverans**

**Leveringsomvang**  
**Contenuto**  
**Toimituslaajuus**  
**Contenido**

**Leverancens omfang**  
**设备构件**  
**제품의 공급 (구성품)**  
**製品及び付属品**

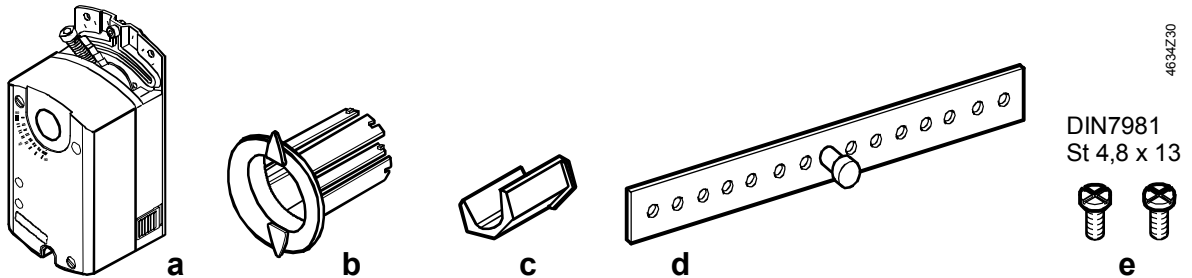

**B**

**Hinweise / Warnungen**  
**Notes / Warnings**  
**Indications / Mise en garde**  
**Hänvisningar / Varningar**

**Aanwijzingen / Waarschuwingen**  
**Messa in servizio / Indicazioni**  
**Huomauksia / Varoituksia**  
**Indicaciones / Consejos**

**Bemærkninger / Advarsler**  
**提示 / 警告**  
**주의사항**  
**保護等級 / 注意**

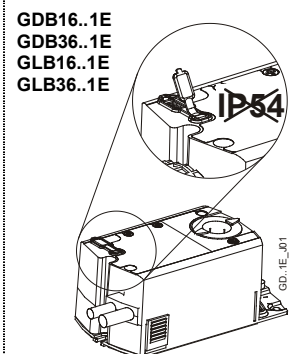
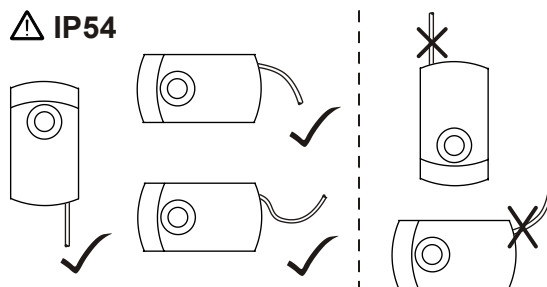
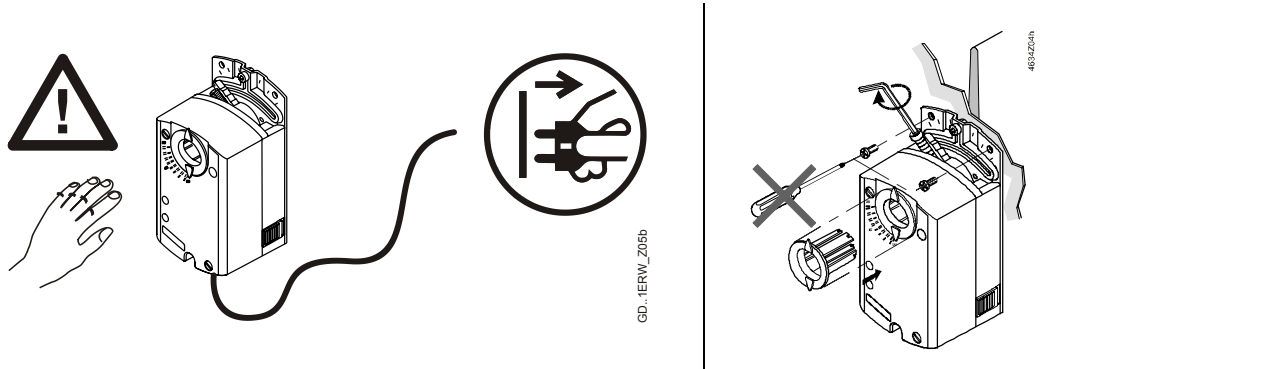



**de**

**Diese Anleitung ist beim Antrieb oder in der Anlagendokumentation aufzubewahren!**

 Dieses Symbol weist auf Gefahren und Massnahmen zum Schutz von Personen und Sachen hin:

- Antriebe für AC 100...240 V ~ dürfen nur durch autorisiertes Personal angeschlossen werden.
- Zulässige Spannungen an den Hilfsschaltern: Siehe Tabelle unter "Geräteschaltpläne".
- Die Anschlusskabel des Antriebs dürfen nicht im Wasser liegen.

 Gerät der Schutzklasse II (Schutzisolierung)

 Gerät der Schutzklasse III (Schutzisolierung)

 **Achtung!** Der Stellantrieb darf nicht geöffnet werden

#### Voreinstellung

Werkseitig eingestellt: 5°.

#### Handverstellung des Antriebes \*\*\*

#### Verdrahtung und Inbetriebnahme

Siehe in den anlagenspezifischen Unterlagen und in der Basisdokumentation "Technische Grundlagen" A6V10636139 zum Antrieb.

**sv**

**Denna instruktion skall förvaras tillsammans med ställdonet eller anläggningsdokumentationen!**

 Denna symbol gäller riskfaktorer samt åtgärder för att undvika person- och materialskador.

- Ställdon med AC 100...240 V ~ får anslutas endast av behörig personal.
- Tillåten spänning för hjälpkontakter, se tabellen i avsnitt kopplingscheman.
- Ställdonets anslutningskabel får inte ligga i vatten.

 Apparat i isolerclass II (skyddsisolering)

 Apparat i isolerclass III (skyddsisolering)

 **OBS!** Ställdonet får inte öppnas.

#### Förinställning

Fabriksinställning: 5°.

#### Manuell manövrering \*\*\*

#### Elektrisk inkoppling och igångkörning

Se anläggnings-specifika underlag och grundläggande beskrivning "Handbok A6V10636139" för ställdonet.

**fi**

**Tätä ohjetta tulee säilyttää toimimoottorin läheisyydessä tai yhdessä laitosdokumenttien kanssa!**

 Tämä symboli viittaa vaaraan ja toimenpiteisiin, joita tarvitaan henkilö- ja aineellisten vahinkojen välttämiseksi:

- Ainoastaan valtuutetut ammattihenkilöt saavat liittää AC 100...240 V ~:n toimimoottoreita.
- Sallitut jännitteet apukytkimissä: katso "Kytkenäkaaviot"-kappaleessa oleva taulukko.
- Toimimoottorin liitäntäkaapelit eivät saa kastua tai muuten altistua vedelle.

 Suojausluokan II laite (suoraerotus)

 Suojausluokan III laite (suojaerotus)

 **Huomio!** Toimimoottoria ei saa avata.

#### Akselin

Tehdasasetus: 5°.

#### Toimimoottorin käsiohjeus \*\*\*

#### Johdotus ja käyttöönnotto

Katso laitoskohtaiset dokumentit ja toimimoottorin tekninen käsikirja A6V10636139.

**en**

**Store these instructions together with the actuator or with the plant documentation!**

 This symbol denotes dangers and measures to avoid personal injury and property damage:

- Only authorized personnel may connect actuators for AC 100...240 V ~.
- Refer to the table in "Diagrams" for the voltages permissible at the auxiliary switches.
- Do not expose the actuator's connecting cables to water or lay the cables in water.

 Device of protection class II (protective insulation)

 Device of protection class III (protective insulation)

 **Warning!** Do not open the actuator.

#### Presetting

Factory set: 5°.

#### Manual override of the actuator \*\*\*

#### Wiring and commissioning

Refer to the actuator's commissioning instructions and document "Technical basics" A6V10636139.

**nl**

**Deze handleiding moet bij de servomotor, of met de documentatie van de installatie worden bewaard!**

 Dit symbool wijst op gevaar en maatregelen ter bescherming van personen en materiaal:

- AC 100...240 V ~ aandrijvingen mogen alleen door bevoegd personeel worden aangesloten.
- Voor toelaatbare spanningen aan hulpschakelaars: Zie tabel onder "Aansluitschema's"
- De aansluitkabel van de aandrijving mag niet in het water liggen.

 Apparaat van beschermingsklasse II (beschermings isolatie)

 Apparaat van beschermingsklasse III (beschermings isolatie)

 **Opgelet!** De servomotor mag niet worden geopend.

#### Voorinstelling

Fabriksmatig ingestelde: 5°

#### Handmatige verstelling van de servomotor \*\*\*

#### Bekabeling en inbedrijfstelling

Raadpleeg de installatie-documentatie en de basisdocumentatie "technische grondslagen" A6V10636139 van de servomotor.

**es**

**Conserve estas instrucciones con el actuador o con la documentación de la instalación!**

 Este símbolo denota peligro y medidas para evitar daños personales y de la propiedad:

- Sólo el personal autorizado puede conectar los actuadores a AC 100...240 V ~.
- Consultar la tabla de "Conexiónado eléctrico" para saber la tensión permitida en los contactos auxiliares
- No exponer los cables de conexión del actuador al agua ni dejarlos en contacto con ésta.

 Equipo con tipo de protección II (aislamiento protegido)

 Equipo con tipo de protección III (aislamiento protegido)

 **Atención!** el actuador no debe ser abierto.

#### Preajuste

Ajuste de fábrica: 5°.

#### Posicionamiento manual del actuador \*\*\*

#### Cableado y puesta en marcha

Ver la documentación técnica "Technical basics" A6V10636139 del actuador.

**fr**

**Cette instruction est à conserver avec le servomoteur ou avec la documentation de l'installation!**

 Ce symbole signale un danger pour les personnes et les biens et les mesures y-afférentes :

- Le branchement des servomoteurs AC 100...240 V ~ ne doit être effectué que par un personnel qualifié.
- Tensions admissibles sur les contacts auxiliaires : cf. "Schémas de raccordement"
- Les câbles de raccordement du servomoteur ne doivent pas être en contact avec l'eau.

 Classe d'isolation II (isolation de protection)

 Classe d'isolation III (isolation de protection)

 **Attention!** Le servo-moteur ne doit pas être ouvert.

#### Préreglage

Préreglé à l'usine: 5°.

#### Positionnement manuel du servo-moteur \*\*\*

#### Câblage et mise en service

se référer à la documentation de l'installation et au manuel technique A6V10636139 du servomoteur.

**it**

**Queste istruzioni devono essere conservate con la documentazione dell'impianto!**

 Questo simbolo indica - pericolo - il personale deve fare attenzione per evitare ferite o danni.

- I collegamenti a AC 100...240 V ~. devono sempre essere eseguiti da personale autorizzati.
- Fare riferimento alle " tabelle tecniche" per la tensione ammessa per i contatti ausiliari.
- Non esporre all'acqua il cavo ed i collegamenti elettrici.

 Apparecchi di protezione classe II (protezione isolamento)

 Apparecchio di protezione classe III (protezione isolamento)

 **Attenzione!** Il servocomando non deve essere aperto.

#### Collega Regolazione

Alla consegna: 5°.

#### Posizionamento manuale del servocomando \*\*\*

#### menti e messa in servizio

Consultare la documentazione per l'installazione e il foglio tecnico A6V10636139 del servocomando.

**da**

**Opbevar denne vejledning sammen med motoren eller med anlægssdokumentationen!**

 Dette symbol gør opmærksom på farer og forholdsregler til beskyttelse af personer og genstande:

- Motorer til AC 100...240 V ~ må kun tilsluttes af autoriserede personer.
- Tilladte spændinger til hjælpekontakter: Se skema under "Apparatdiagrammer"
- Motorens tilslutningskabler må ikke ligge i vand.

 Apparat i isoleringsklasse II (beskyttelsesisolering)

 Apparat i isoleringsklasse III (beskyttelsesisolering)

 **OBS!** Motoren må ikke åbnes.

#### Forindstilling

Fabriksindstillet: 5°.

#### Manuel justering af motor \*\*\*

#### Eltilslutning og idriftsættelse

Se den anlægsspecifikke dokumentation samt basisdokumentationen "Tekniske principper" A6V10636139 for motoren.

zh

请将此安装指导文件与驱动器或现场文件保存在一起。



此符号代表危险和须要采取措施以免对人及财产产生损害:

- 只有被授权的工程人员才可进行 AC 100...240 V ~ 交流电压的电气安装。
- 请参考“图内”有关辅助开关可容许电压表。

不要将已连接电线的驱动器暴露在水中及将电线安放在水中。



设备安全等级 II (绝缘保护)



设备安全等级 III (绝缘保护)



注意! 请不要打开驱动器

预先设定

出厂时设定制为: 5° .

手动并关驱动器 \*\*\*

驱动器接线和调试

请察看调试指导和驱动器技术资料A6V10636139

ko

본 지침서는 조작기 또는 관련 설비 자료와 함께 보관 한다.



위험요소 와 더불어 인사 및 재산상의 피해를 방지 하기 위한 표시(심볼):

- 전기적 결선(AC 100...240 V ~)은 반드시 전기 공사 면허가 있는 사람에 의해 시행 되어야 한다.
  - 보조스위치의 접점용량은 "다이어그램" 상의 테이블에 표시된 내용을 참고한다.
- 조작기의 연결 케이블은 물에 닿지 않도록 주의 한다.



전기안전규격(CE 절연규격): Class II



전기안전규격(CE 절연규격): Class III



주 의! 조작기를 임의로 열지 마시오.

설정

공장 출하 시 설정: 5°.

수동 조작기 \*\*\*

결선 및 시운전

시운전 지침 또는 "기술 자료" A6V10636139 를

참조

ja

ダンパーアクチュエータを取付ける場合には、この説明書に従い行って下さい。



この注意書きを守らないと、傷害を伴う危険と共に、機器を破損する事があります。

- AC 100~240Vのためのアクチュエータは認定された担当者のみ接続できます。
- 補助スイッチの電圧仕様については、接続図の項を参照して下さい。
- アクチュエータへの配線は、水に浸したり、雨にさらされる事の無い様施工して下さい。



絶縁保護クラス II



絶縁保護クラス III



注意! カバーを外さない事。

シャフトアダプタを前もって調整すること。

工場設定 : 5°

マニュアルオーバーライド \*\*\*

配線及び調整

製品の仕様書を参照して下さい。

C

Montage auf Klappenachse  
Shaft Mounting  
Montage sur l'axe des volets  
Montering på spjællaxel

Montage op de luchtklepas  
Montaggio sull'asse della serranda  
Asennus pellin akseliin  
Montaje sobre el eje de las comp.

Montering på spjældakse  
軸的安裝  
조작기의 설치  
ダンパーシャフトへの取付

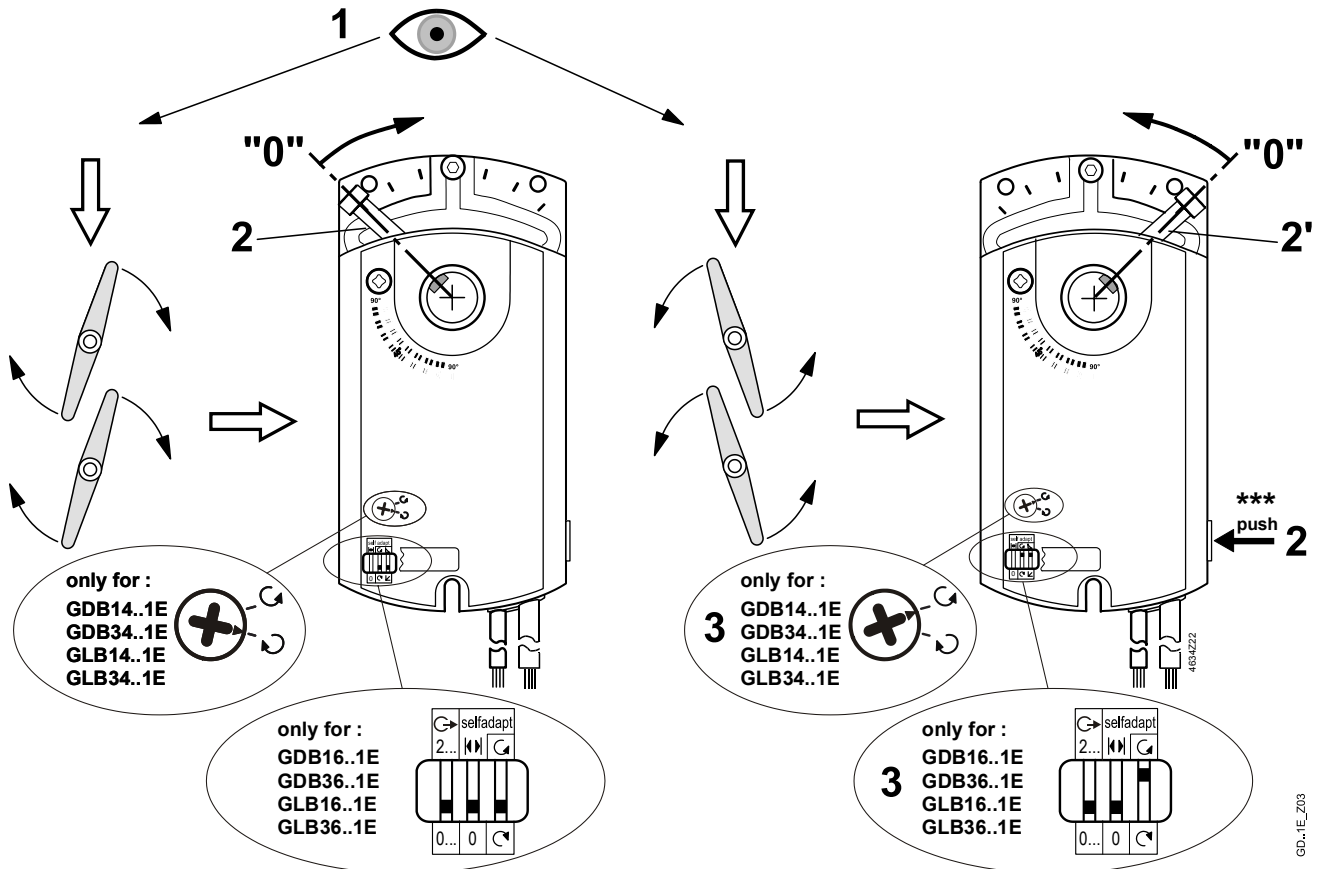

GD..1E\_Z03

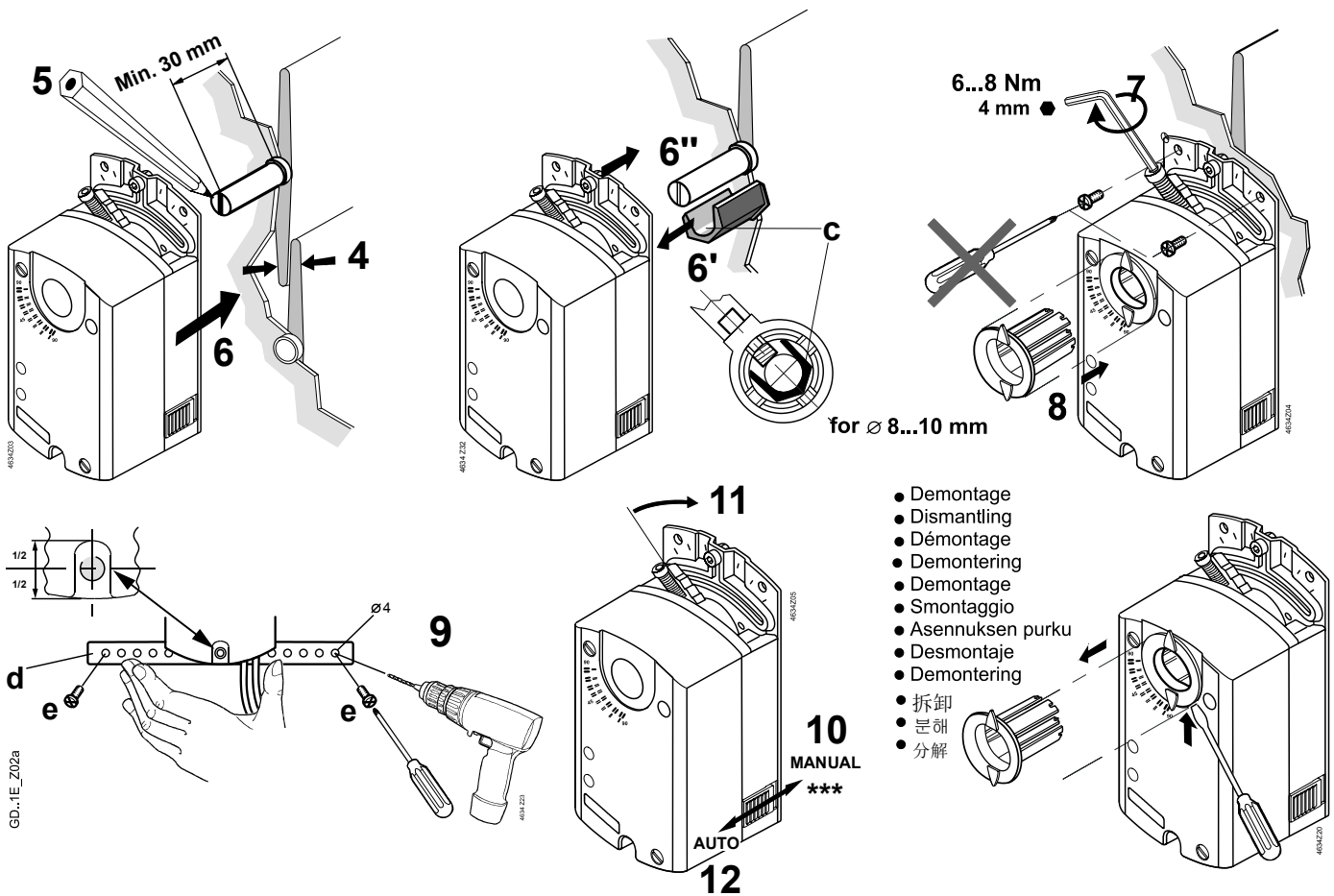

**D** Drehwinkelbegrenzung / Limitation of rotary angle / Limitage de l'angle de rotation / Begränsning av vridningsvinkel / Begrenzing van de draaihoek / Limitatore dell'angolo di rotazione / Käätökulman rajoitus / Límites del ángulo de rotación / Begrænsning af drejevinkel / 旋转角度的限位设置 / 회전범위의 기계적 제한 / 回転角度を制限する場合

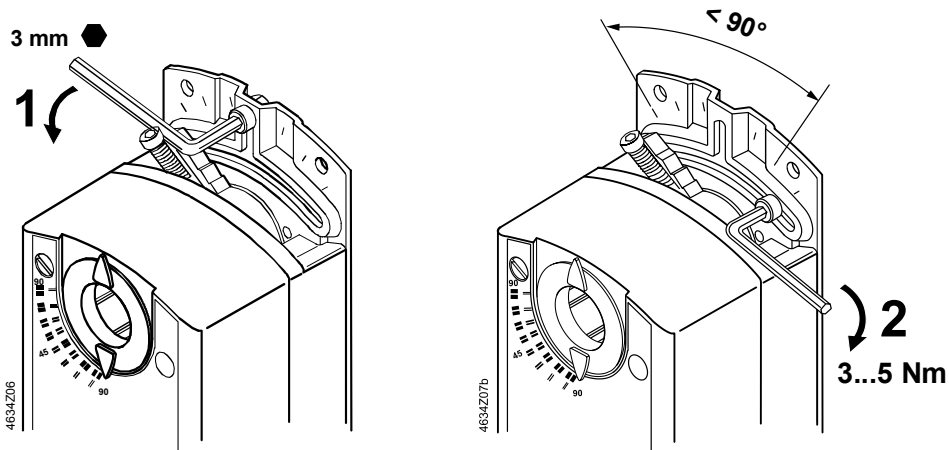

# E

**Einstellung: Hilfsschalter A, B**  
**Setting: Auxiliary switches A, B**  
**Réglage: Contact auxiliaire A, B**  
**Inställning: Hjälpkontakt A, B**

**Instelling: Hulpschakelaar A, B**  
**Taratura: Contatto ausiliario A, B**  
**Asettelu: Apukytkin A, B**  
**Ajuste: Contacto auxiliar A, B**

**Indstilling: Hjelpekontakt A, B**  
**设定辅助开关**  
**보조 스위치의 설정**  
**補助スイッチの設定**

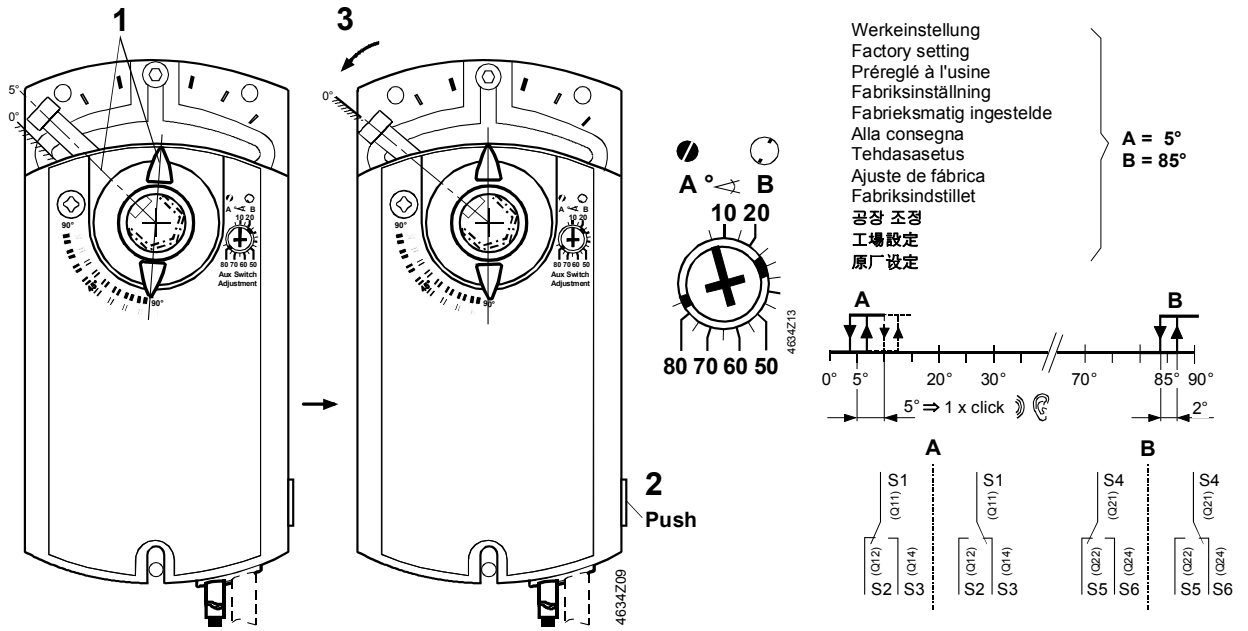

# F

**Massbild**  
**Dimensions**  
**Encombrement**  
**Måttuppgift**

**Maatschets**  
**Ingombri**  
**Mittapiirros**  
**Dimensiones**

**Målskitse**  
**尺寸**  
**외형치수**  
**外形寸法**

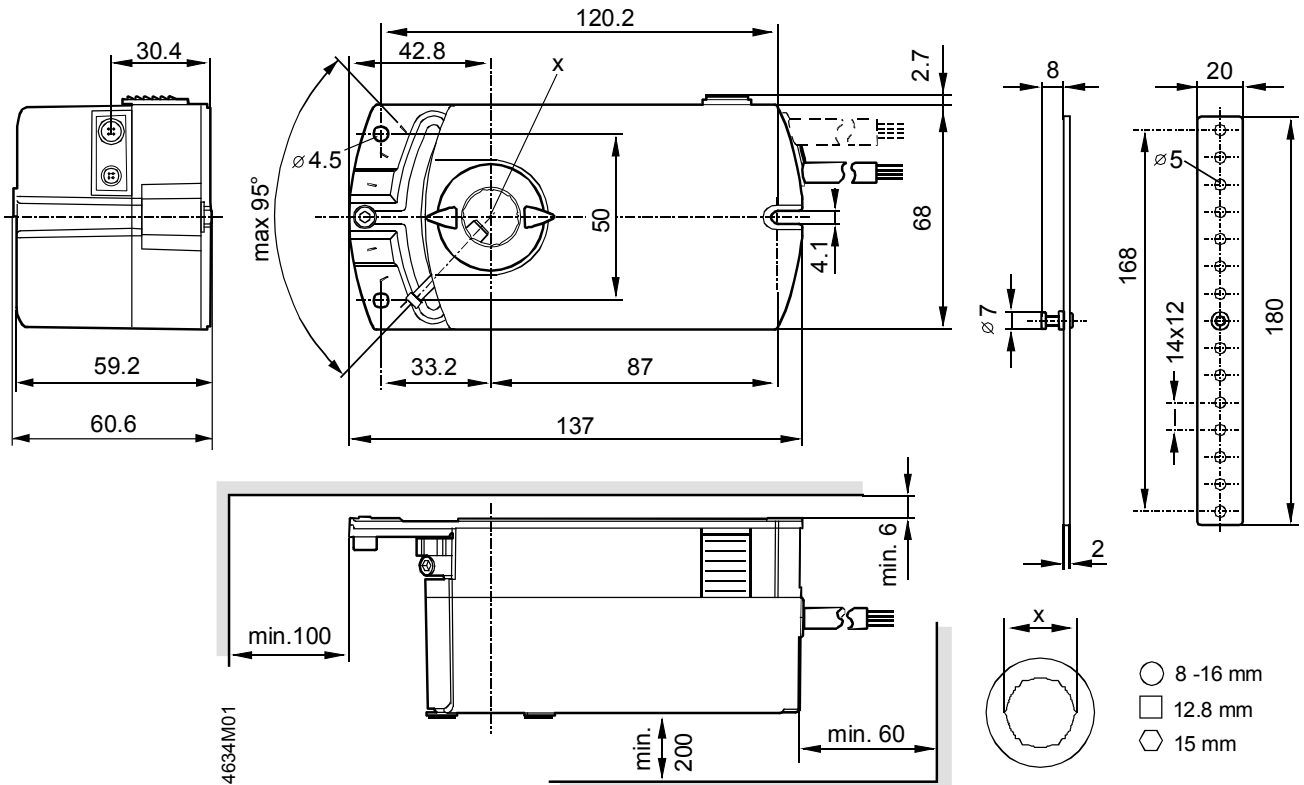

Masse in mm  
 Dimensions in mm  
 Dimensions en mm

Mått i mm  
 Afmetingen in mm  
 Dimensioni in mm

Mitá mm  
 Dimensiones en mm  
 Mál i mm

尺寸单位 mm  
 치수 단위 mm  
 单位 mm



**Geräteschaltpläne**  
**Wiring diagrams**  
**Schémas de raccordement**  
**Kopplingscheman**

**Aansluitschema's**  
**Schemi di collegamento**  
**KytKentäkaaviot**  
**Conexionado eléctrico**

**Apparatdiagrammer**  
**接线图**  
**결선 회로도**  
**配線接続図**

**GDB14..1E, GLB14..1E**

AC 24 V ~ / DC 24...48 V ~

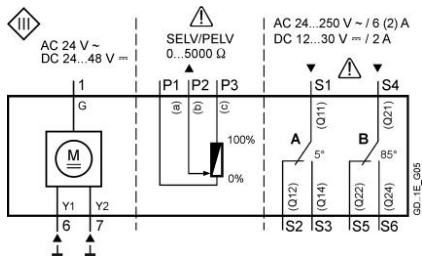

**SPST**

Auf / ZU  
ON / OFF  
MARCHE/ARRET  
PÅ/AV  
AAN/UIT  
ON / OFF

AUKI/KIINNI  
CON./DESC.  
TIL/FRA  
开/关  
켜기/끄기  
オン/オフ

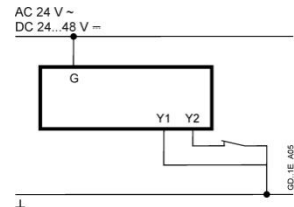

**SPDT**

Auf / ZU  
ON / OFF  
MARCHE/ARRET  
PÅ/AV  
AAN/UIT  
ON / OFF

AUKI/KIINNI  
CON./DESC.  
TIL/FRA  
开/关  
켜기/끄기  
オン/オフ

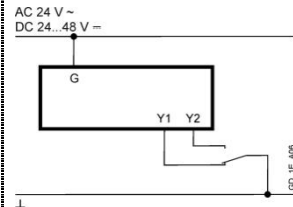

**3P**

3-Punkt  
3P  
Comm. 3 p.  
Treläges styrning  
Driepuntsbesturing  
Comando a 3 punti

Kolmipisteohjaus  
Control a 3 p.  
Trepunktsstyrning  
三位控制  
3-위치 제어  
3位置タイプ

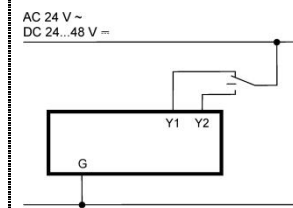
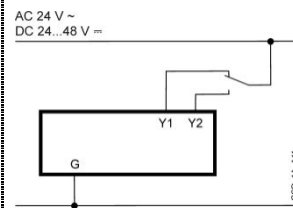
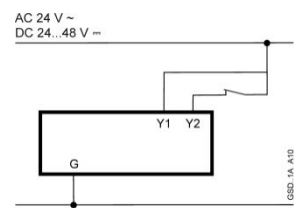
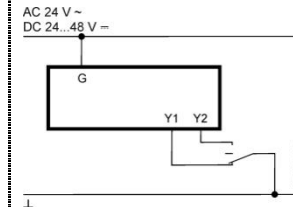

**GDB34..1E, GLB34..1E**

AC 100...240 V ~

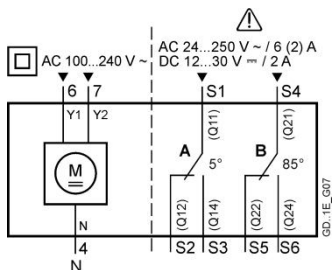

**SPST**

Auf / ZU  
ON / OFF  
MARCHE/ARRET  
PÅ/AV  
AAN/UIT  
ON / OFF

AUKI/KIINNI  
CON./DESC.  
TIL/FRA  
开/关  
켜기/끄기  
オン/オフ

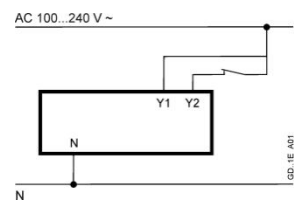

**SPDT**

Auf / ZU  
ON / OFF  
MARCHE/ARRET  
PÅ/AV  
AAN/UIT  
ON / OFF

AUKI/KIINNI  
CON./DESC.  
TIL/FRA  
开/关  
켜기/끄기  
オン/オフ

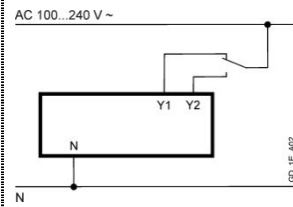

**3P**

3-Punkt  
3P  
Comm. 3 p.  
Treläges styrning  
Driepuntsbesturing  
Comando a 3 punti

Kolmipisteohjaus  
Control a 3 p.  
Trepunktsstyrning  
三位控制  
3-위치 제어  
3位置タイプ

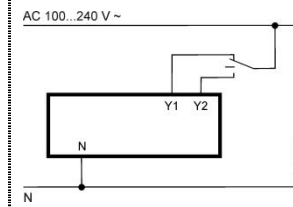

**GDB16..1E, GLB16..1E**

AC 24 V ~ / DC 24...48 V ~

Stetigsteuerung DC 0/2...10 V  
Modulating control DC 0/2...10 V  
Commande progressif DC 0/2...10 V  
Kontinuerlig styrsignal 0/2...10 V DC  
Modulere besturing 0/2...10 VDC  
Comando analogico 0/2...10 V c.c.  
Moduloiva ohjaus 0/2...10 V DC  
Control continuo 0/2...10 VCC  
Kontinuerlig styring DC 0/2...10 V  
DC 0/2...10V连续量控制  
DC 0/2...10V 비례제어  
DC 0/2...10V 比例タイプ

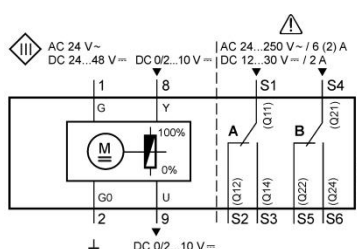

Stetigsteuerung DC 0...35 V  
Modulating control DC 0...35 V  
Commande progressif DC 0...35 V  
Kontinuerlig styrsignal 0...35 V DC  
Modulere besturing 0...35 VDC  
Comando analogico 0...35 V c.c.  
Moduloiva ohjaus 0...35 V DC  
Control continuo 0...35 VCC  
Kontinuerlig styring DC 0...35 V  
DC 0...35V连续量控制  
DC 0...35V 비례제어  
DC 0...35V 比例タイプ

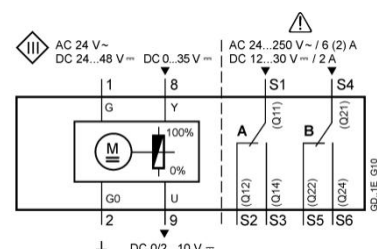

# GDB361.1E, GLB361.1E

AC 100...240 V ~

- Stetigsteuerung DC 0/2...10 V
- Modulating control DC 0/2...10 V
- Commande progressif DC 0/2...10 V
- Kontinuierlig styrsignal 0/2...10 V DC
- Modulere besturing 0/2...10 VDC
- Comando analogico 0/2...10 V c.c.
- Moduloiva ohjtaus 0/2...10 V DC
- Control continuo 0/2...10 VCC
- Kontinuierlig styring DC 0/2...10 V
- DC 0/2...10V连续量控制
- DC 0/2...10V 비례저어
- DC 0/2...10V 比例タイプ

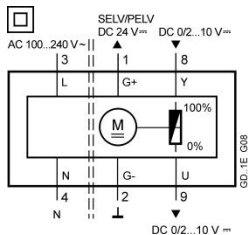

Voltage	Switch A (S1) 辅助开关 A 스위치 A スイッチA	Switch B (S4) 辅助开关 B 스위치 B スイッチB	ok / no!
AC 24 V ~	AC 24 V ~	AC 24 V ~	ok
AC 100...240 V ~	L1 (phase) L2 L3 Lx (phase)	L1 (phase) L2 L3 ≠ Lx (phase)	ok ok ok no!
Mixed	AC 24 V ~ AC 100...240 V ~	AC 100...240 V ~ AC 24 V ~	no! no!

de

## Kabelbezeichnungen

Anschluss	Kabel				Bedeutung
	Code	Nr.	Farbe	Abkürzung	
Antriebe AC 24 V ~ DC 24...48 V =	G	1	rot	RD	System Potential AC 24 V ~ / DC 24...48 V =
	G0	2	schwarz	BK	Systemnull
	Y1	6	violett	VT	Stellsignal AC/DC 0 V "Uhrzeigersinn" (G..B14..1E)
	Y2	7	orange	OG	Stellsignal AC/DC 0 V "Gegenuhrzeigersinn" (G..B14..1E)
	Y	8	grau	GY	Signaleingang (G..B16..1E)
	U	9	rosa	PK	Signalausgang (G..B16..1E)
Antriebe AC 100...240 V ~	L	3	braun	BR	Phase AC 100...240 V ~
	N	4	hellblau	BU	Nullleiter
	Y1	6	schwarz	BK	Stellsignal AC 100...240 V ~, "Uhrzeigersinn" (G..B34..1E)
	Y2	7	weiss	WH	Stellsignal AC 100...240 V ~, "Gegenuhrzeigersinn" (G..B34..1E)
	G+	1	rot	RD	System Potential DC 24 V = (G..B361.1E)
	G-	2	schwarz	BK	Systemnull (G..B361.1E)
	Y	8	grau	GY	Signaleingang (G..B361.1E)
	U	9	rosa	PK	Signalausgang (G..B361.1E)
	Rückführ- potentiometer	a	P1	weiss/rot	WHRD
b		P2	weiss/blau	WHBU	Potentiometer Abgriff
c		P3	weiss/rosa	WHPK	Potentiometer 100...0 % (P3-P2)
Hilfsschalter	Q11	S1	grau/rot	GYRD	Schalter A Eingang
	Q12	S2	grau/blau	GYBU	Schalter A Ruhekontakt
	Q14	S3	grau/rosa	GYPK	Schalter A Schliesskontakt
	Q21	S4	schwarz/rot	BKRD	Schalter B Eingang
	Q22	S5	schwarz/blau	BKBU	Schalter B Ruhekontakt
	Q24	S6	schwarz/rosa	BKPK	Schalter B Schliesskontakt

en

## Wire designations

Connection	Cable				Meaning
	Code	No.	Color	Abbreviation	
AC 24 V ~ DC 24...48 V = Actuators	G	1	red	RD	System potential AC 24 V ~ / DC 24...48 V =
	G0	2	black	BK	System neutral
	Y1	6	purple	VT	Positioning signal AC/DC 0 V "clockwise" (G..B14..1E)
	Y2	7	orange	OG	Positioning signal AC/DC 0 V "anticlockwise" (G..B14..1E)
	Y	8	grey	GY	Signal in (G..B16..1E)
	U	9	pink	PK	Signal out (G..B16..1E)
AC 100...240 V ~ Actuators	L	3	brown	BR	Line AC 100...240 V ~
	N	4	light blue	BU	Neutral
	Y1	6	black	BK	Positioning signal AC 100...240 V ~, "clockwise" (G..B34..1E)
	Y2	7	white	WH	Positioning signal AC 100...240 V ~, "anticlockwise" (G..B34..1E)
	G+	1	red	RD	System potential DC 24 V = (G..B361.1E)
	G-	2	black	BK	System neutral (G..B361.1E)
	Y	8	grey	GY	Signal in (G..B361.1E)
	U	9	pink	PK	Signal out (G..B361.1E)
	Feedback potentiometer	a	P1	white/red	WHRD
b		P2	white/blue	WHBU	Potentiometer pick-off
c		P3	white/pink	WHPK	Potentiometer 100...0 % (P3-P2)
Auxiliary switch	Q11	S1	gray/red	GYRD	Switch A input
	Q12	S2	gray/blue	GYBU	Switch A normally closed contact
	Q14	S3	gray/pink	GYPK	Switch A normally open contact
	Q21	S4	black/red	BKRD	Switch B input
	Q22	S5	black/blue	BKBU	Switch B normally closed contact
	Q24	S6	black/pink	BKPK	Switch B normally open contact

Câbles de raccordement	Câble				Signification
	Code	No.	Couleurs	Abbreviation	
servo-moteurs AC 24 V ~ DC 24...48 V ==	G	1	rouge	RD	potentiel du système AC 24 V ~ / DC 24...48 V == zéro du système signal de commande AC/DC 0 V "sens horaire" (G..B14..1E) signal de comm. AC/DC 0 V "sens anti-horaire" (G..B14..1E) entrée signal (G..B16..1E) sortie signal (G..B16..1E)
	G0	2	noir	BK	
	Y1	6	violet	VT	
	Y2	7	orange	OG	
	Y	8	gris	GY	
	U	9	rose	PK	
servo-moteurs AC 100...240 V ~	L	3	brun	BR	Phase AC 100...240 V ~ neutre signal de commande AC 100...240 V ~, "sens horaire" (G..B34..1E) signal de commande AC 100...240 V ~, "sens anti-horaire" (G..B34..1E) potentiel du système DC 24 V == (G..B361.1E) zéro du système entrée signal (G..B361.1E) sortie signal (G..B361.1E)
	N	4	bleu clair	BU	
	Y1	6	noir	BK	
	Y2	7	blanc	WH	
	G+	1	rouge	RD	
	G-	2	noir	BK	
	Y	8	gris	GY	
	U	9	rose	PK	
potentiomètre de retour	a	P1	blanc/rouge	WHRD	potentiomètre 0...100 % (P1-P2) potentiomètre curseur potentiomètre 100...0 % (P3-P2)
	b	P2	blanc/bleu	WHBU	
	c	P3	blanc/rose	WHPK	
commutateurs auxiliaires	Q11	S1	gris/rouge	GYRD	commutateur A entrée commutateur A contact de repos commutateur A contact de travail commutateur B entrée commutateur B contact de repos commutateur B contact de travail
	Q12	S2	gris/bleu	GYBU	
	Q14	S3	gris/rose	GYPK	
	Q21	S4	noir/rouge	BKRD	
	Q22	S5	noir/bleu	BKBU	
	Q24	S6	noir/rose	BKPK	

连接	线缆				注解
	端子号	端子	颜色	缩写	
AC 24 V ~ DC 24...48 V == 驱动器	G	1	红色	RD	供电类型为 AC 24 V ~ / DC 24...48 V == 中性 驱动器控制信号 AC/DC 0 V "顺时针旋转" (G..B14..1E) 驱动器控制信号 AC/DC 0 V "逆时针旋转" (G..B14..1E) 信号输入 (G..B16..1E) 信号输出 (G..B16..1E)
	G0	2	黑色	BK	
	Y1	6	紫色	VT	
	Y2	7	橙色	OG	
	Y	8	灰色	GY	
	U	9	粉色	PK	
AC 100...240 V ~ 驱动器	L	3	啡色	BR	相线 AC 100...240 V ~ 中性 驱动器控制信号 AC 100...240 V ~ "顺时针旋转" (G..B34..1E) 驱动器控制信号 AC 100...240 V ~ "逆时针旋转" (G..B34..1E) 供电类型为 DC 24 V == (G..B361.1E) 中性 信号输入 (G..B361.1E) 信号输出 (G..B361.1E)
	N	4	淡蓝色	BU	
	Y1	6	黑色	BK	
	Y2	7	白色	WH	
	G+	1	红色	RD	
	G-	2	黑色	BK	
	Y	8	灰色	GY	
	U	9	粉色	PK	
位置反馈 电位计	a	P1	白/红	WHRD	电位计算器 0...100 % (P1-P2) 电位计滑块 电位计算器 100...0 % (P3-P2)
	b	P2	白/蓝	WHBU	
	c	P3	白/粉	WHPK	
辅助开关	Q11	S1	灰/红	GYRD	辅助开关 A 输入公共端子 辅助开关 A 常闭端子 辅助开关 A 常开端子 辅助开关 B 输入公共端子 辅助开关 B 常闭端子 辅助开关 B 常开端子
	Q12	S2	灰/蓝	GYBU	
	Q14	S3	灰/粉	GYPK	
	Q21	S4	黑/红	BKRD	
	Q22	S5	黑/蓝	BKBU	
	Q24	S6	黑/粉	BKPK	

구분	케이블				내용
	코드	번호	색상	약어(약자)	
AC 24 V ~ DC 24...48 V == 조작기	G	1	적색	RD	공급전원 AC 24 V ~ / DC 24...48 V == 시스템 뉴트럴(N) 동작신호 AC/DC 0 V "시계방향 회전" (G..B14..1E) 동작신호 AC/DC 0 V "반시계방향 회전" (G..B14..1E) 신호 입력 (G..B16..1E) 신호 출력 (G..B16..1E)
	G0	2	흑색	BK	
	Y1	6	자주색	VT	
	Y2	7	오렌지색	OG	
	Y	8	회색	GY	
	U	9	분홍색	PK	
AC 100...240 V ~ 조작기	L	3	갈색	BR	동작신호 AC 100...240 V ~ 뉴트럴(N) 동작신호 AC 100...240 V ~ "시계방향 회전" (G..B34..1E) 동작신호 AC 100...240 V ~ "반시계방향 회전" (G..B34..1E) 공급전원 DC 24 V == (G..B361.1E) 시스템 뉴트럴(N) 신호 입력 (G..B361.1E) 신호 출력 (G..B361.1E)
	N	4	연하파란색	BU	
	Y1	6	흑색	BK	
	Y2	7	흰색	WH	
	G+	1	적색	RD	
	G-	2	흑색	BK	
	Y	8	회색	GY	
	U	9	분홍색	PK	
포텐쇼미터	a	P1	흰색/적색	WHRD	가변저항 0...100 % (P1-P2) 총림 가변저항 100...0 % (P3-P2)
	b	P2	흰색/청색	WHBU	
	c	P3	흰색/분홍색	WHPK	
보조 스위치	Q11	S1	회색/적색	GYRD	스위치 A 입력 스위치 A (노멀 클로즈 접점) 스위치 A (노멀 오픈 접점) 스위치 B 입력 스위치 B (노멀 클로즈 접점) 스위치 B (노멀 오픈 접점)
	Q12	S2	회색/청색	GYBU	
	Q14	S3	회색/분홍색	GYPK	
	Q21	S4	흑색/적색	BKRD	
	Q22	S5	흑색/청색	BKBU	
	Q24	S6	흑색/분홍색	BKPK	



内容	ケーブル				仕様	
	コード	No.	色	記号		
電源 AC 24 V ~ DC 24...48 V =	G	1	赤	RD	システムポテンシャル AC 24 V ~ / DC 24...48 V = システムニュートラル 操作信号 AC/DC 0V “時計廻り” (G.B14..1E) 操作信号 AC/DC 0V “反時計廻り” (G.B14..1E) 信号オン (G.B16..1E) 信号オフ (G.B16..1E)	
	G0	2	黒	BK		
	Y1	6	紫	VT		
	Y2	7	オレンジ	OG		
	Y	8	灰	GY		
	U	9	ピンク	PK		
電源 AC 100...240 V ~	L	3	茶	BR	相電圧 AC 100...240 V - ニュートラル 操作信号 AC 100...240 V - “時計廻り” (G.B34..1E) 操作信号 AC 100...240 V - “反時計廻り” (G.B34..1E) システムポテンシャル DC 24 V = (G.B361.1E) システムニュートラル 信号オン (G.B361.1E) 信号オフ (G.B361.1E)	
	N	4	薄青色	BU		
	Y1	6	黒	BK		
	Y2	7	白	WH		
	G+	1	赤	RD		
	G-	2	黒	BK		
	Y	8	灰	GY		
		U	9	ピンク		PK
フィードバック ポテンシオメータ	a	P1	白/赤	WHRD	ポテンシオメータ 0...100%(P1-P2) ポテンシオメータ コモン ポテンシオメータ 100..0%(P3-P2)	
	b	P2	白/青	WHBU		
	c	P3	白/ピンク	WHPK		
補助スイッチ	Q11	S1	灰/赤	GYRD	スイッチA コモン スイッチA “常時閉”信号 スイッチA “常時開”信号 スイッチB コモン スイッチB “常時閉”信号 スイッチB “常時開”信号	
	Q12	S2	灰/青	GYBU		
	Q14	S3	灰/ピンク	GYPK		
	Q21	S4	黒/赤	BKRD		
	Q22	S5	黒/青	BKBU		
	Q24	S6	黒/ピンク	BKPK		





Issued by  
Siemens Switzerland Ltd  
Building Technologies Division  
International Headquarters  
Gubelstrasse 22  
6301 Zug  
Switzerland  
Tel. +41 41-724 24 24  
[www.siemens.com/buildingtechnologies](http://www.siemens.com/buildingtechnologies)

© Siemens Switzerland Ltd, 2016

Technical specifications and availability subject to change without notice.